

April 2007

Understanding Molecular Orbitals; Sigma Orbitals

Carl W. David

University of Connecticut, Carl.David@uconn.edu

Follow this and additional works at: http://digitalcommons.uconn.edu/chem_educ

Recommended Citation

David, Carl W., "Understanding Molecular Orbitals; Sigma Orbitals" (2007). *Chemistry Education Materials*. 44.
http://digitalcommons.uconn.edu/chem_educ/44

Understanding Molecular Orbitals; Sigma-Orbitals

C. W. David

Department of Chemistry

University of Connecticut

Storrs, Connecticut 06269-3060

(Dated: April 18, 2007)

I. SYNOPSIS

Molecular Orbitals differ significantly from atomic orbitals. One of their major sources of confusion, at least to diatomic molecular orbitals, is the nature of the coordinate system employed. The drawings herein are intended to help understand these orbitals.

II. INTRODUCTION

The standard coordinate system for treating diatomic molecules places one nucleus (A) at $(0,0,R/2)$ and the other (B) at $(0,0,-R/2)$, as has been discussed repeatedly in these pages. If we attempt to build a molecular orbital

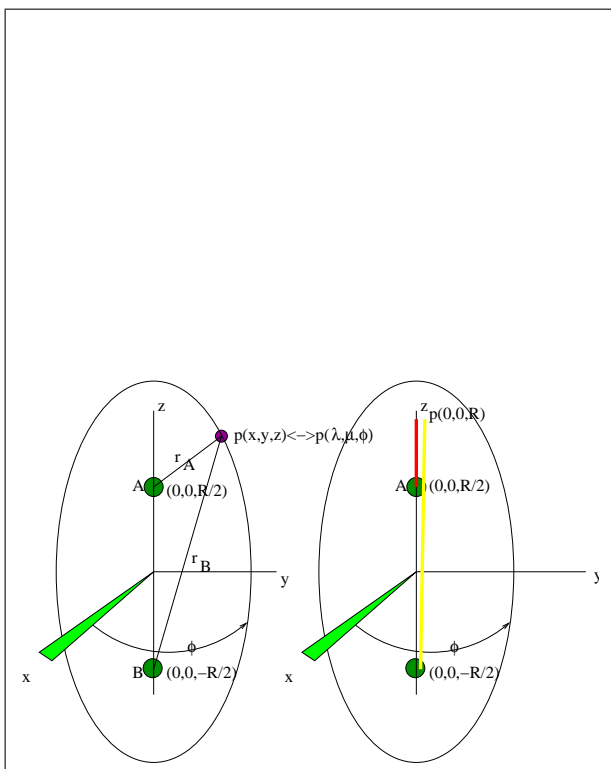

FIG. 1: The Elliptical Coordinate System for Diatomic Molecules. The μ coordinate is not depicted.

from hydrogenic 1s orbitals, by placing one on nucleus A and the other on nucleus B then their form is no longer the simple Cartesian form we've become accustomed to

using. Instead,

$$r_A = \sqrt{x^2 + y^2 + (z - R/2)^2} \quad (2.1)$$

$$r_B = \sqrt{x^2 + y^2 + (z + R/2)^2} \quad (2.2)$$

so, for a trial (sigma) LCAO-MO (an approximate wave function, not an eigenfunction of the H_2^+ system)

$$\psi_{\text{trial } \sigma} = (c_A e^{-\alpha r_A} + c_B e^{-\alpha r_B}) \quad (2.3)$$

We already know that for the homonuclear case the coefficients are equal, so we make them "one" for our purposes here. We then have

$$\psi_{\sigma} = (e^{-\alpha r_A} + e^{-\alpha r_B}) \quad (2.4)$$

which we are interested in representing. Before that, however, let's introduce the anti bonding orbital

$$\psi_{\sigma^*} = (e^{-\alpha r_A} - e^{-\alpha r_B}) \quad (2.5)$$

III. ONE DIMENSIONAL PLOTS (ALONG THE z-AXIS)

We employ our (now) standard tricks for capturing the essence of these functions, starting with one dimensional plots of $\psi_{1\sigma}(0,0,z)$ versus z . The σ orbital is shown in Figure 2, while the σ^* orbital is shown in Figure 3.

It is clear that the bonding orbital has maxima centered about the nuclei, while the anti bonding orbital has a node, the $x - y$ plane, where $z = 0$.

IV. PSEUDO 3D PLOTS

The σ orbital is shown in Figure 4, while the σ^* orbital is shown in Figure 5.

V. 3D CONTOUR PLOTS

The σ orbital is shown in Figure 6, while the σ^* orbital is shown in Figure 7.

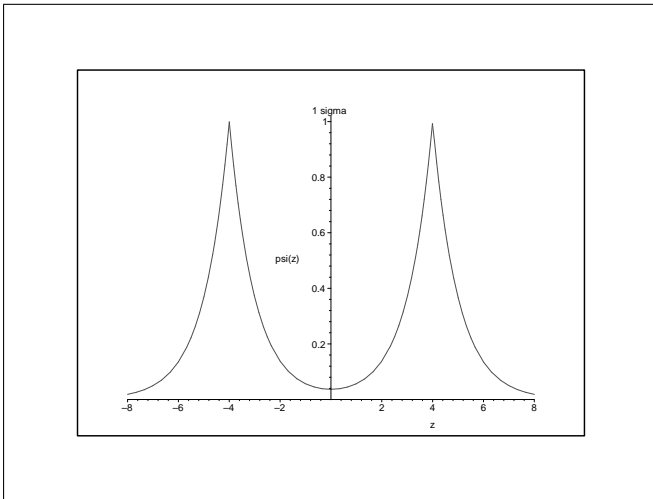

FIG. 2: The $\psi_{1\sigma}(0, 0, z)$ orbital, plotted against z

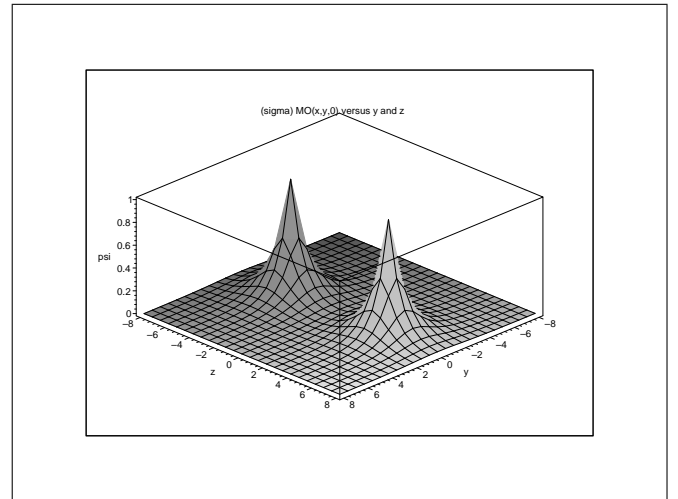

FIG. 4: The $\psi_{1\sigma}(0, y, z)$ orbital, plotted against y and z

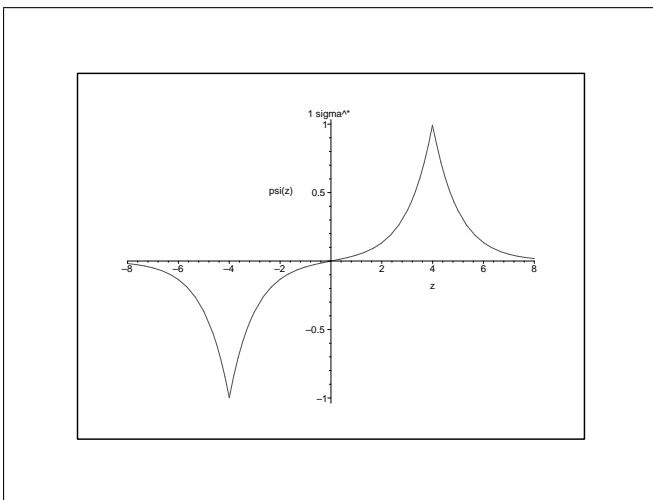

FIG. 3: The $\psi_{1\sigma^*}(0, 0, z)$ orbital, plotted against z

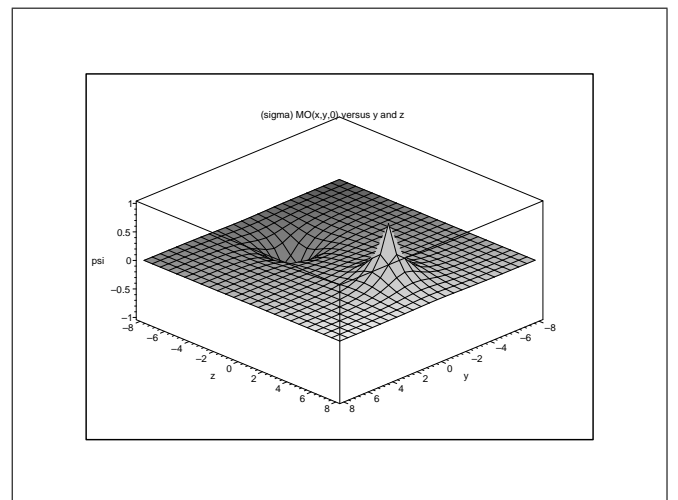

FIG. 5: The $\psi_{1\sigma^*}(0, y, z)$ orbital, plotted against y and z

VI. THE p_σ ORBITALS

There is another orbital pair which are labeled σ , but built from p_z orbitals rather than s orbitals. Remember, the bond axis is contained in the z -axis. That means that p_z orbitals are parallel to the bond axis (we expected them to be at right angles to the bond, but those are the p_x and p_y orbitals, which become π_x and π_y respectively).

To continue, we put one p_z orbital on nucleus A and the other on nucleus B. The wave function now becomes

$$\psi_{p_\pm} = \left(\left(z - \frac{R}{2} \right) e^{-\alpha r_A} \pm \left(z + \frac{R}{2} \right) e^{-\alpha r_B} \right) \quad (6.1)$$

which reminds us that the orbitals are centered on two different locations in physical space. When we plot this we obtain Figure 8 as our first, linear plot. This is, of

course, $\psi_{p_\sigma^*}(0, 0, z$ versus z being plotted. Notice how weird this is *vide infra*.

Next we plot the bonding orbital, which is better behaved. Figure 9 shows the symmetry of the bonding orbital. We return now to the anti-bonding orbital, and show the contributors in colors so that the odd function being plotted can be understood (see Figure 10). Finally, we plot the contour (3D) map of this orbital, which shows the weird, interdigitated, positive and negative lobes. We note in passing that the Maple code for these last few plots is not included in the text.

VIII. MAPLE CODE

Here is the Maple code which generated the figures to follow:

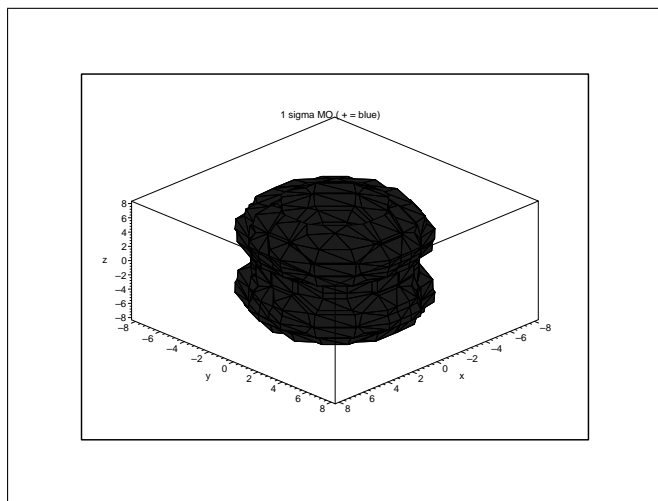

FIG. 6: The contour surface of $\psi_{1\sigma}(x, y, z)$ orbital, plotted against x , y and z

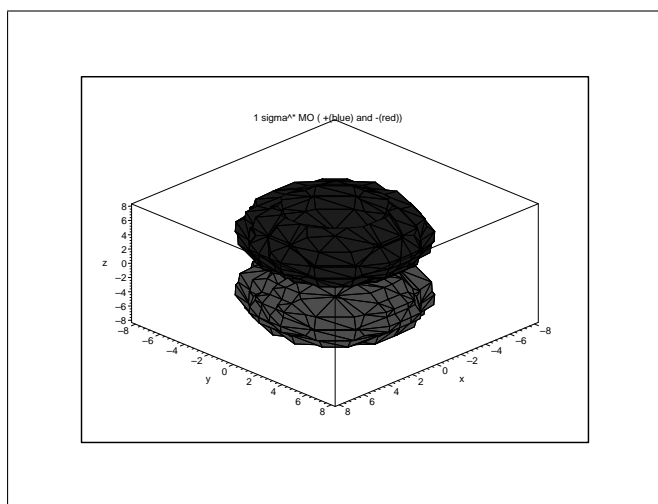

FIG. 7: The contour surfaces of $\psi_{1\sigma^*}(0, 0, z)$ orbital, plotted against x , y and z

VII. CONCLUSION

The rigid understanding of the functionality of the contributing atomic orbitals to the resultant molecular orbital leads to a broad comprehension of what these orbitals “look” like.

```
> #MO-hybrid-plot
> restart;
> with(plots);
> fsA := exp(-rA);
> fsB := exp(-rB); rA :=
sqrt(x^2+y^2+(z-R/2)^2);
> rB := sqrt(x^2+y^2+(z+R/2)^2);
> psi_plus := exp(-rA) + exp(-rB);
> psi_minus := exp(-rA) - exp(-rB);
```

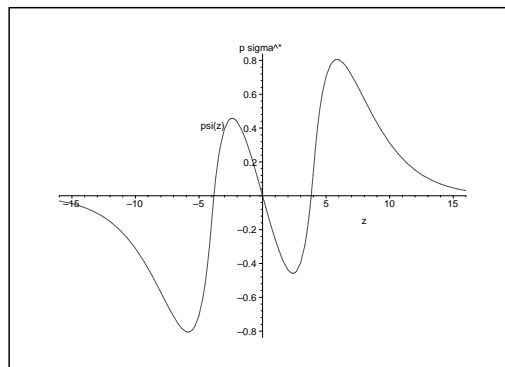

FIG. 8: The anti-bonding p_σ orbital versus z

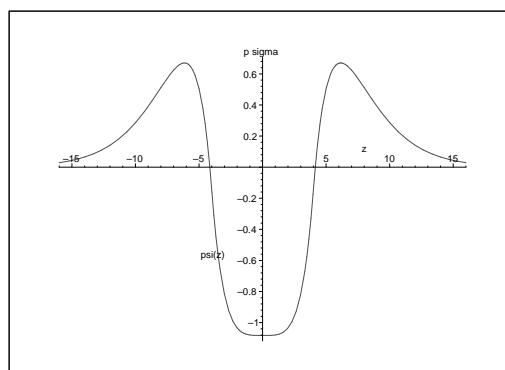

FIG. 9: The bonding p_σ orbital versus z

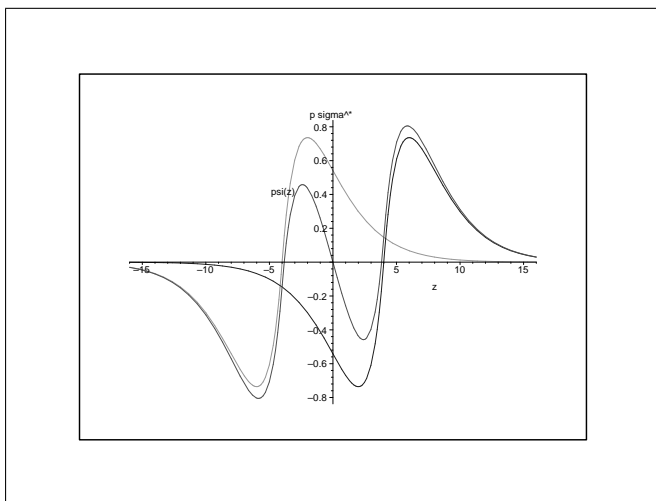

FIG. 10: The anti bonding p_σ orbital versus z broken up into its constituent parts to show where the odd shape comes from.

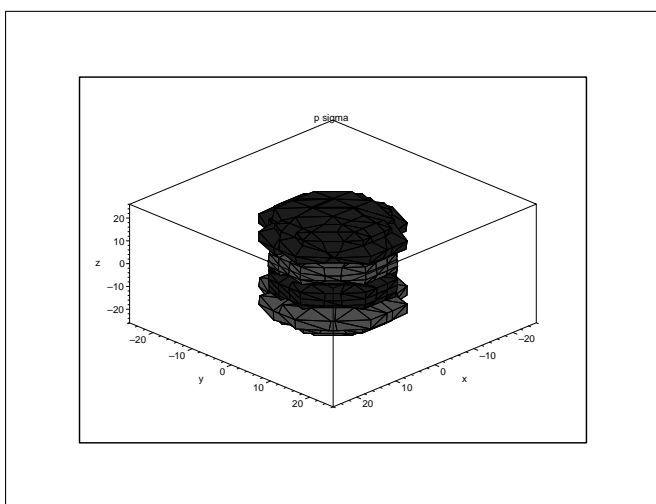

FIG. 11: The anti bonding p_σ orbital versus z broken up into its constituent parts to show where the odd shape comes from.

Warning, the name `changecoords` has been redefined

[*animate, animate3d, animatecurve, arrow, changecoords, complexplot, complexplot3d, conformal, conformal3d, contourplot, contourplot3d, coordplot, coordplot3d, cylinderplot, densityplot, display, display3d, fieldplot, fieldplot3d, gradplot, gradplot3d, graphplot3d, implicitplot, implicitplot3d, inequal, interactive, listcontplot, listcontplot3d, listdensityplot, listplot, listplot3d, loglogplot, logplot, matrixplot, odeplot, pareto, plotcompare, pointplot, pointplot3d, polarplot, polygonplot, polygonplot3d, polyhedra-supported, polyhedraplot, replot, rootlocus, semilogplot, setoptions, setoptions3d, spacecurve, sparsematrixplot, sphereplot, surfdata, textplot, textplot3d, tubeplot*]

$$fsA := e^{(-rA)}$$

$$fsB := e^{(-rB)}$$

$$rA := \frac{\sqrt{4x^2 + 4y^2 + 4z^2 - 4zR + R^2}}{2}$$

$$rB := \frac{\sqrt{4x^2 + 4y^2 + 4z^2 + 4zR + R^2}}{2}$$

$$psi_plus := e^{(-\frac{\sqrt{4x^2 + 4y^2 + 4z^2 - 4zR + R^2}}{2})} + e^{(-\frac{\sqrt{4x^2 + 4y^2 + 4z^2 + 4zR + R^2}}{2})}$$

$$psi_minus := e^{(-\frac{\sqrt{4x^2 + 4y^2 + 4z^2 - 4zR + R^2}}{2})} - e^{(-\frac{\sqrt{4x^2 + 4y^2 + 4z^2 + 4zR + R^2}}{2})}$$

```

> #note, un-normalized orbitals in use!
> lim := 8;
> plot(subs(R=8,x=0,y=0,psi_plus),z=-lim..lim,labels=['z','psi(z)'],title='1 sigma');
> plot(subs(R=8,x=0,y=0,psi_minus),z=-lim..lim,labels=['z','psi(z)'],title='1 sigma*');
> plot3d(subs(R=8,x=0,psi_plus),y=-lim..lim,z=-lim..lim,axes=BOXED,labels=['y','z','psi'],title='(sigma) MO(x,y,0) versus y and z');
> plot3d(subs(R=8,x=0,psi_minus),y=-lim..lim,z=-lim..lim,axes=BOXED,labels=['y','z','psi'],title='(sigma) MO(x,y,0) versus y and z');
> implicitplot3d(subs(R=8,psi_plus)=0.006,x=-lim..lim,y=-lim..lim,z=-lim..lim,axes=BOXED,labels=['x','y','z'],color=blue,title='1 sigma MO (+ = blue)');
> f1 :=
> implicitplot3d(subs(R=8,psi_minus)=-0.006,x=-lim..lim,y=-lim..lim,z=-lim..lim,axes=BOXED,labels=['x','y','z'],color=red):
> f2 :=
> implicitplot3d(subs(R=8,psi_minus)=0.006,x=-lim..lim,y=-lim..lim,z=-lim..lim,axes=BOXED,labels=['x','y','z'],color=blue):
> display(f1,f2,title='1 sigma* MO (+(blue) and -(red))');

```
